



# KS-CS

S E R I E S

## *User's Manual*

*ACTIVE SPEAKER CABINET CLASS D WITH DSP*  
**KS-CS 8A / 10A / 12A / 15A / 215A**  
**KS15A SUB / 18A SUB / 218A SUB / 21A SUB**

---

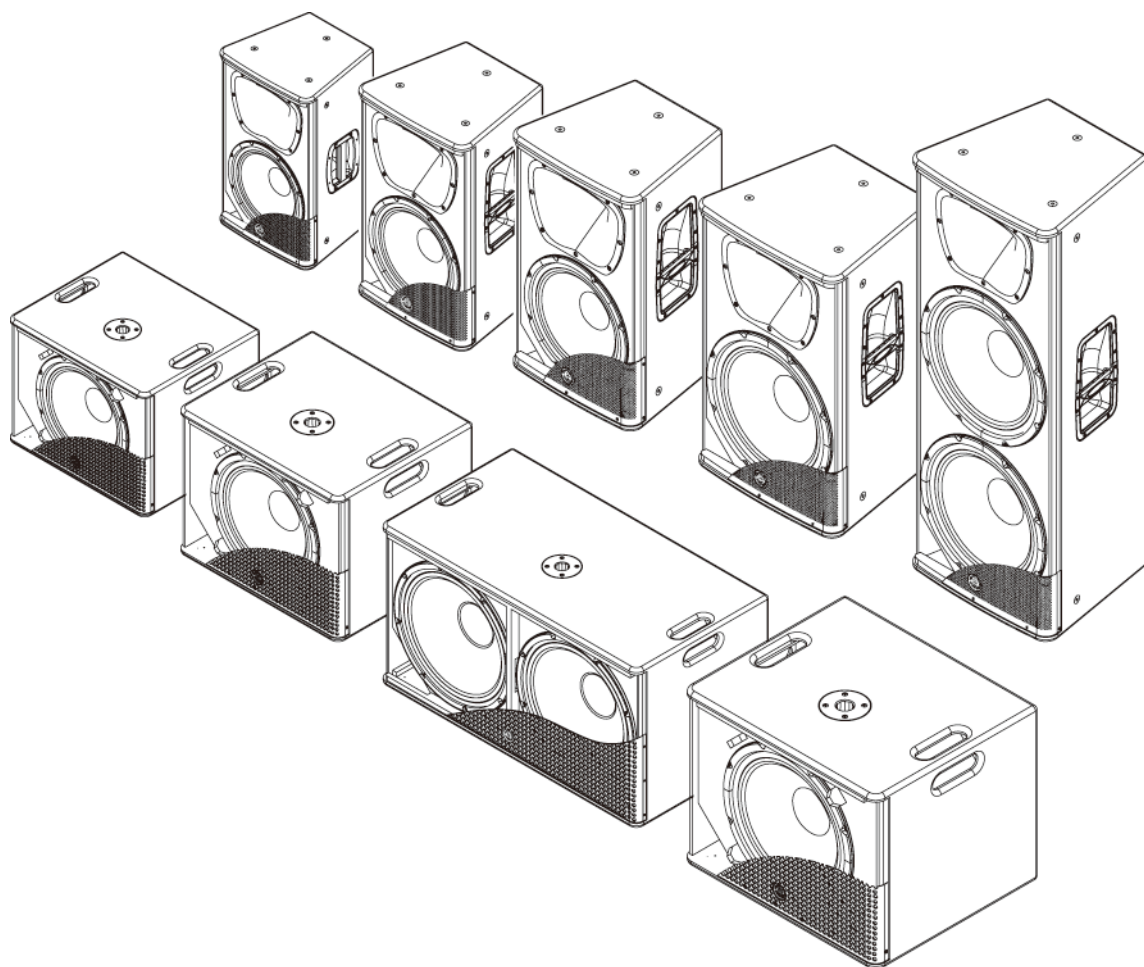

## Important Safety Instructions



TO REDUCE THE RISK OF ELECTRIC SHOCK PLEASE DO NOT REMOVE THE COVER OR THE BACK PANEL OF THIS EQUIPMENT. THERE ARE NO PARTS NEEDED BY USER INSIDE THE EQUIPMENT. FOR SERVICE, PLEASE CONTACT QUALIFIED SERVICE CENTERS.



This symbol, wherever used, alerts you to the presence of un-insulated and dangerous voltages in the product enclosure. These are voltages that may be sufficient to constitute the risk of electric shock or death.



This symbol, wherever used, alerts you to important operating and maintenance instructions. Please read.



Protective Ground Terminal



AC mains (Alternating Current)



Hazardous Live Terminal

ON: Denotes the product is turned on.

OFF: Denotes the product is turned off.

### CAUTION

Describes precautions that should be observed to prevent damage to the product.

1. Read this Manual carefully before operation.
2. Keep this Manual in a safe place.
3. Be aware of all warnings reported with this symbol. 
4. Keep this Equipment away from water and moisture.
5. Clean it only with dry cloth. Do not use solvent or other chemicals.
6. Do not damp or cover any cooling opening. Install the equipment only in accordance with the Manufacturer's instructions.
7. Power Cords are designed for your safety. Do not remove Ground connections! If the plug does not fit your AC outlet, seek advice from a qualified electrician. Protect the power cord and plug from any physical stress to avoid risk of electric shock. Do not place heavy objects on the power. This could cause electric shock or fire.
8. Unplug this equipment when unused for long periods of time or during a storm.
9. Refer all service to qualified service personnel only. Do not perform any servicing other than those instructions contained within the User's Manual.
10. To prevent fire and damage to the product, use only the recommended fuse type as indicated in this manual. Do not short-circuit the fuse holder.

### WARNING

To reduce the risk of electric shock and fire, do not expose this equipment to moisture or rain.



Dispose of this product should not be placed in municipal waste and should be separate collection.

Before replacing the fuse, make sure that the product is OFF and disconnected from the AC outlet.

11. Move this Equipment only with a cart, stand, tripod, or bracket, specified by the manufacturer, or sold with the Equipment. When a cart is used, use caution when moving the cart / equipment combination to avoid possible injury from tip-over.



12. Permanent hearing loss may be caused by exposure to extremely high noise levels. The US. Government's Occupational Safety and Health Administration (OSHA) has specified the permissible exposure to noise level. These are shown in the following chart:

Hours x day	SPL	Example
8	90	Small gig
6	92	Train
4	95	Subway train
3	97	High level desktop monitors
2	100	Classic music concert
1.5	102	
1	105	
0.5	110	
0.25 or less	115	Rock Concert

According to OSHA, an exposure to high SPL in excess of these limits may result in the loss of hearing. To avoid the potential damage of hearing, it is recommended that Personnel exposed to equipment capable of generating high SPL use hearing protection while such equipment is under operation.

The apparatus shall be connected to a mains socket outlet with a protective earthing connection.

The mains plug or an appliance coupler is used as the disconnect device, the disconnect device shall remain readily operable.

## Table of Contents

---

1. PROLOGUE.....	4
2. FEATURES.....	4
3. USEFULL DATA.....	4
4. BACK PANEL DESCRIPTION.....	5
5. CONNECTION PLATE.....	8
6. FREQUENCY RESPONSE DIAGRAMS.....	11
7. WIRE CONNECTIONS.....	14
8. TECHNICAL SPECIFICATIONS.....	15
9. GUARANTEE.....	20
10. NOTES.....	21

- **KS-CS 8A, KS-CS 10A** are Active Speakers for professional use, they can be used in following electromagnetic environment: residential, commercial and light industrial, urban outdoors. They are the apparatus Not intended for rack mounting.
- For **KS-CS 8A, KS-CS 10A**, the audio input line length is less than 10m.
- For **KS-CS 8A, KS-CS 10A** the peak inrush current is 3.8A
- **KS15A SUB, KS18A SUB, KS218A SUB, KS 21A SUB** are Active Subwoofers for professional use, they can be used in following electromagnetic environment: residential, commercial and light industrial, urban outdoors.  
They are the apparatus Not intended for rack mounting.
- For **KS15A SUB, KS18A SUB, KS 21A SUB** the peak inrush current is 7.46A

Don't forget to visit our website at [www.topppro.com](http://www.topppro.com)  
for more information about this and other Topp Pro products.

# 1

## Prologue

---

Thank you for choosing **TOPP PRO**. The new **TOPP PRO MUSIC GEAR KS-CS** series cabinets have been Designed to provide a cost effective high grade solution while maintaining high quality construction and optimum components.

The **KS-CS** series is designed light weight powered loudspeaker systems and all new class D power amplifiers. The **KS-CS 8A** and **KS-CS 10A** use 800 Watt continuous class D+AB power module and the **KS-CS 12A**, **KS-CS 15A** and **KS-CS 215A** use 1000 Watt continuous class D power module. This series also breaks from the traditional loudspeaker paradigm, every model is fit with the identical 1.75" voice coil Compression Driver and woofer of high quality for unparalleled performance, regardless of speaker size. Extensive DSP processing is employed throughout, providing levels of sonic clarity and total output that defy the system's size and weight. Premium-grade materials, advanced construction processes and multiple mounting and suspension options allow for a wide range of live and installed applications. Great pride & care is placed in delivering products with excellent performance, specifications, and dependable reliability. Every **TOPP PRO** audio product is strictly tested and complied to very strict standards.

Please carefully read this manual before starting operation! Thank you again for choosing **TOPP PRO MUSIC GEAR KS-CS SERIES**.

# 2

## Features

---

### **KS-CS 8A / 10A / 12A / 15A / 215A**

- Attractive and professional appearance.
- 2-Way Active Vented Speaker with DSP.
- 1"EXIT, 1.75" Voice Coil Compression Driver.
- Linkwitz-Riley crossover with 24dB filter slope.
- 1000W Class D BI-AMP (for KS-CS 12A / 15A / 215A), 800W Class D+AB BI-AMP (for KS-CS 8A / 10A).
- Protections: Thermal/ convection fan / overload /Digital Lim / compressor.
- 110-120V~50/60Hz or 220-240V~50/60Hz switchable.
- Plywood cabinet, resistant black paint, metal grille with foam, rubber feet, plastic handle.
- One metal standard pole-mount plus (for KS-CS 10A / 12A / 15A) 12xM10 Flying points, KS-CS 8A 10xM10 flying points,

### **KS15A SUB / 18A SUB / 218A SUB / 21A SUB**

- 1000W Class D BI-AMP for KS15A SUB / 18A SUB, 21A SUB, 2000W for KS218A SUB.
- Connectors: Input: Left Mono (Combo) / Right (XLR-F) / Output: Left Mono / Right (XLR-M), Link-Left / Mono-Right (XLR-M) Balanced 15K ohms.
- Volume control / Power ON with green LED / Clip limiter with Red LED / Ground lift / Switch for Input Sens / Switch On for front Led / IP Control Module (Optional)
- Protections: Thermal/ convection fan / overload /Digital Lim / compressor.
- 110-120V~50/60Hz or 220-240V~50/60Hz switchable.
- Plywood cabinet, resistant black paint, metal grille with foam, rubber feet, double handle.
- One metal standard pole-mount plus

# 3

## Usefull Data

---

Please write your serial number here for future reference.

Serial Number:

Date of Purchase:

Purchased at:

## Back Panel Description

KS-CS 8A / 10A / 12A / 15A / 215A

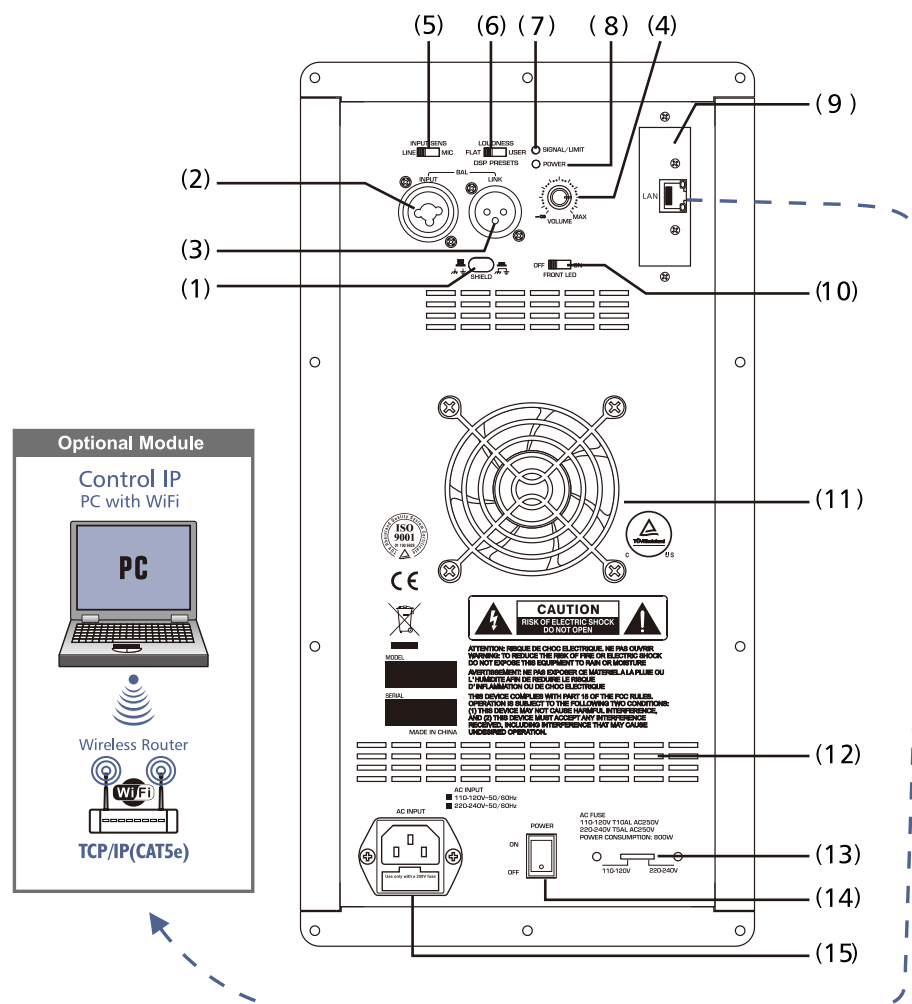

- (1) Gnd switch
- (2) Mic/line in with combo
- (3) Link on XLR
- (4) Volume control
- (5) Switch for input sens
- (6) DSP Presets: Flat / Loudness / User (Custom Sound)  
Flat: preset is suited for live sound reinforcement making sound more enjoyable.  
Loudness: preset is to equalize the mix for optimal music playback.  
User: preset is to change different EQ to match the voice that the user need sound, it can be done by connecting amplifier module to a PC via the LAN port by internet. (the factory preset of User is the same as Flat, after changed, it can be saved into the product)
- (7) Clip LED indicator
- (8) Power LED
- (9) IP Control Module (Optional)
- (10) Switch for front led on or off
- (11) Convection fan
- (12) Vents for heat dissipation and ventilation
- (13) AC input voltage selector
- (14) Main power switch
- (15) Input AC power socket with AC fuse

# 4

## Back Panel Description

### Active Subwoofer KS 15A SUB / 18A SUB / 218A SUB

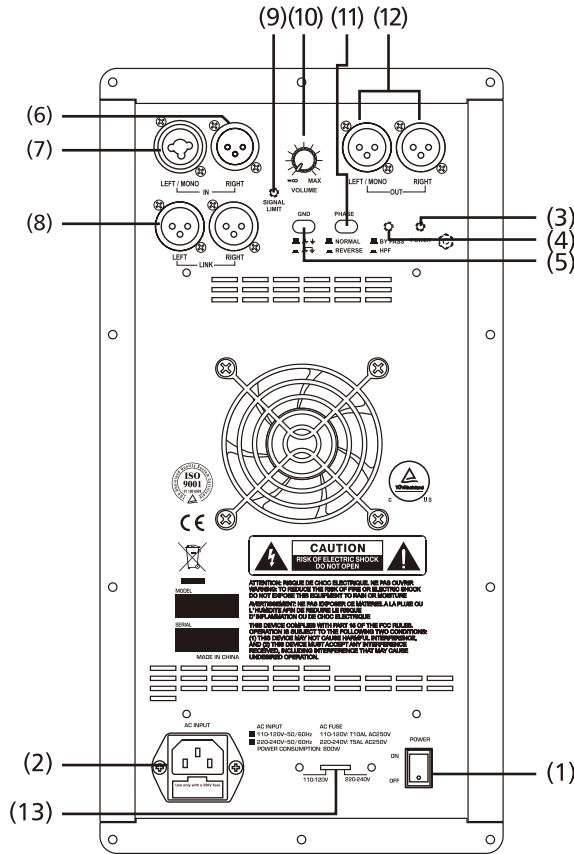

KS 15A SUB / 18A SUB

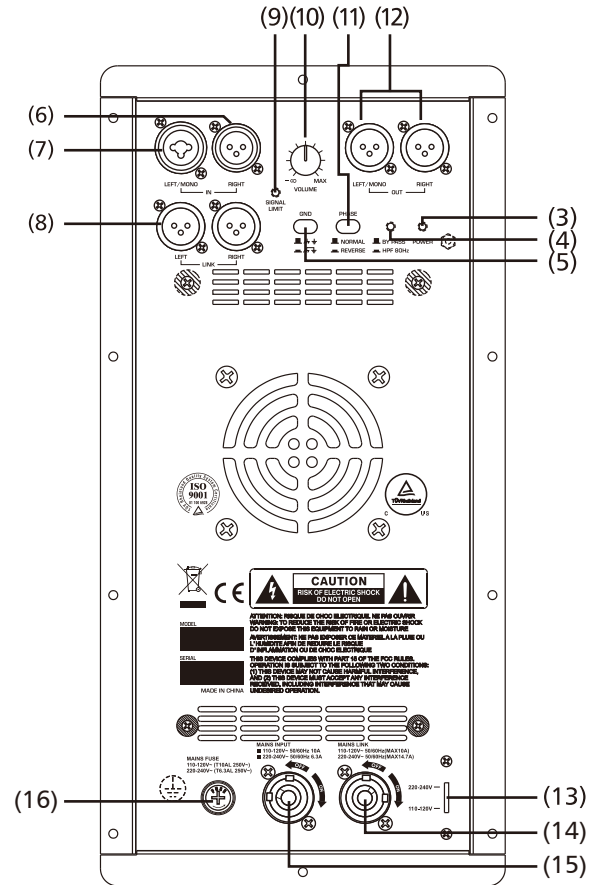

KS 218A SUB

- (1) On-Off Main power switch
- (2) AC Power socket with main fuse
- (3) Power and activity indicator green LED
- (4) High pass filter or bypass selector
- (5) Ground selector (GND)
- (6) Right line input XLR connector
- (7) Left line mono input Combo connector
- (8) Left-Right Link XLR connector
- (9) Limit and signal presence red LED
- (10) Volume main power control
- (11) Normal/Reverse phase switch (Polarity)
- (12) Left-Right Line Output XLR connector
- (13) Voltage selector
- (14) Mains Link
- (15) Mains Input
- (16) Mains Fuse

## Back Panel Description

### Active Subwoofer KS 21A SUB

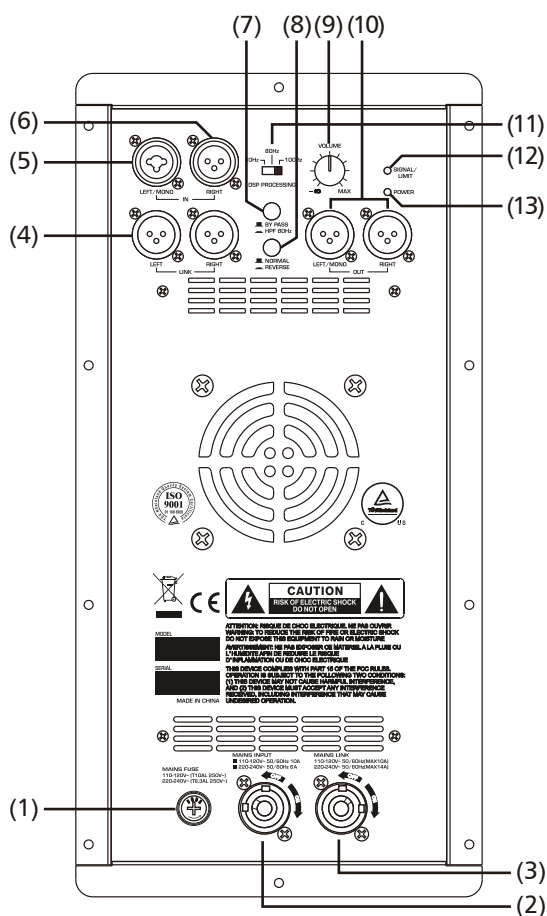

KS 21A SUB

- (1) Mains Fuse
- (2) Mains Input
- (3) Mains Link
- (4) Left-Right Link XLR connector
- (5) Left line mono input Combo connector
- (6) Right line input XLR connector
- (7) High pass filter or bypass selector
- (8) Normal/Reverse phase switch (Polarity)
- (9) Volume main power control
- (10) Left-Right Line Output XLR connector
- (11) Crossover 60Hz / 80Hz / 100Hz
- (12) Limit and signal presence red LED
- (13) Power and activity indicator green LED

# 5

## Connection Plate

**Make your initial connections with all the equipment powered off, and ensure that all the main volume controls are turned down completely.**

### For Active Full Range Speaker System

- 1) Connect one side of the signal cable at your mixer into the Output Left / Right (with Stereo Jack or XLR) and the other side of the cable into the Line Input (COMBO) of your active speaker cabinet (with Stereo Jack or XLR).
- 2) Connect the power cord to main.
- 3) Turn ON your mixer first, then the active speaker cabinets.
- 4) Turn up the volume control of the cabinets.
- 5) Use PFL function to get the proper input level for the mixer, and adjust the Main Mix Level control to reach the desired output level.
- 6) After use, turn off your active speaker cabinets first, then the mixer.

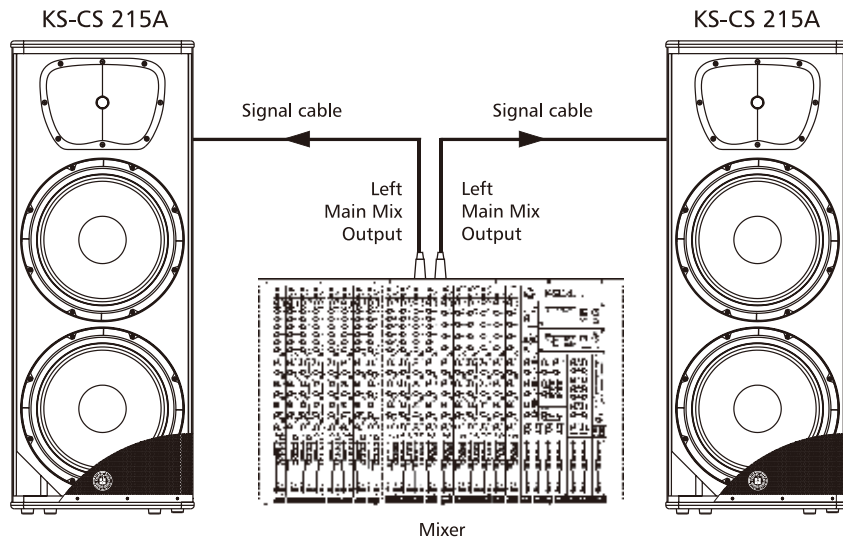
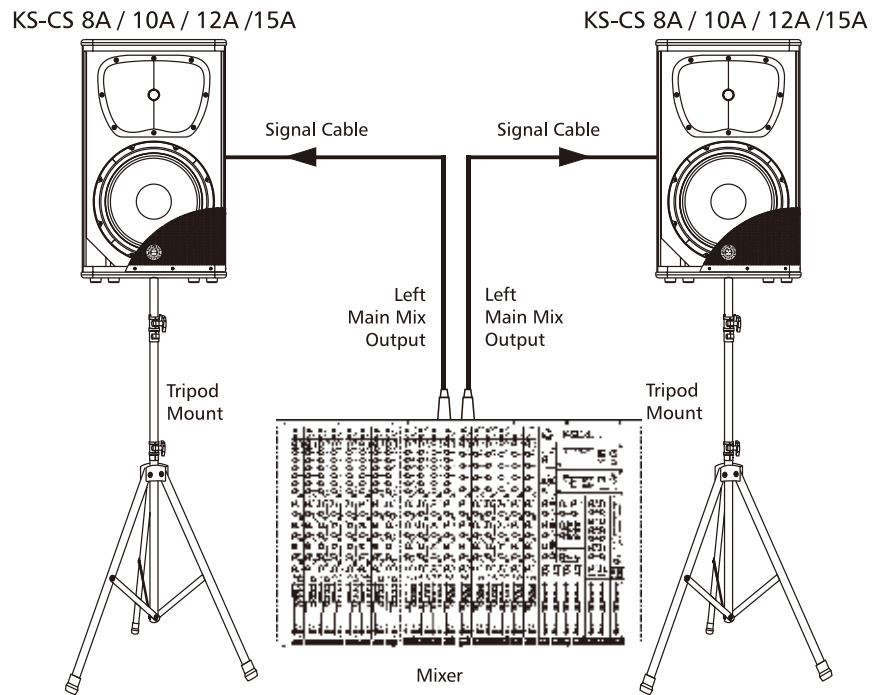



## Connection Plate

**Make your initial connections with all the equipment powered off, and ensure that all the main volume controls are turned down completely.**

### Two Active Subwoofers & Two Active Satellite Speakers

- 1) Connect one side of the signal cable at your mixer into the Output Left / Right and the other side of the cable into the Line Input of your active subwoofers.
- 2) Connect one side of another signal cable at your active subwoofers into Link Left / Right or Out Left / Right, and the other side of the cable into the Line Input Left / Right of your active satellite speakers.  
\* If you connect into Out Left / Right and press Bypass switch, the 80Hz HPF will be activated.
- 3) Connect the power cord to main.
- 4) Turn ON your mixer first, then the active speaker cabinets.
- 5) Turn up the volume control of the active speaker cabinets.
- 6) Use PFL function to get the proper input level for the mixer, and adjust the Main Mix Level control to reach the desired output level.
- 7) After use, turn off your active speaker cabinets first, then the mixer.

KS-CS 8A / 10A / 12A / 15A

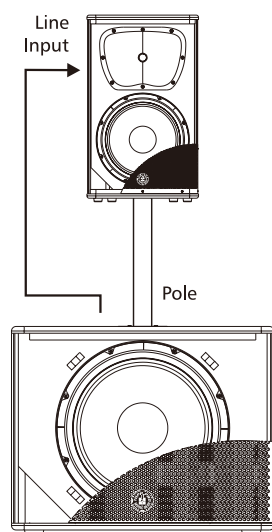

KS 15A /18A /21A SUB

KS-CS 8A / 10A / 12A / 15A

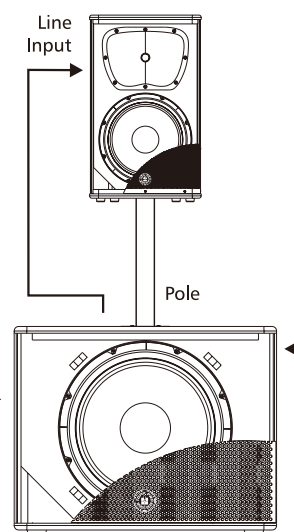

KS 15A /18A /21A SUB

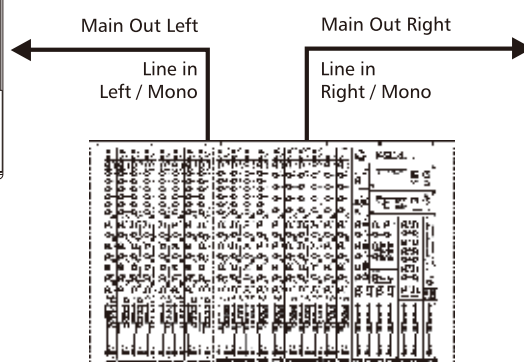

Mixer

# 5

## Connection Plate

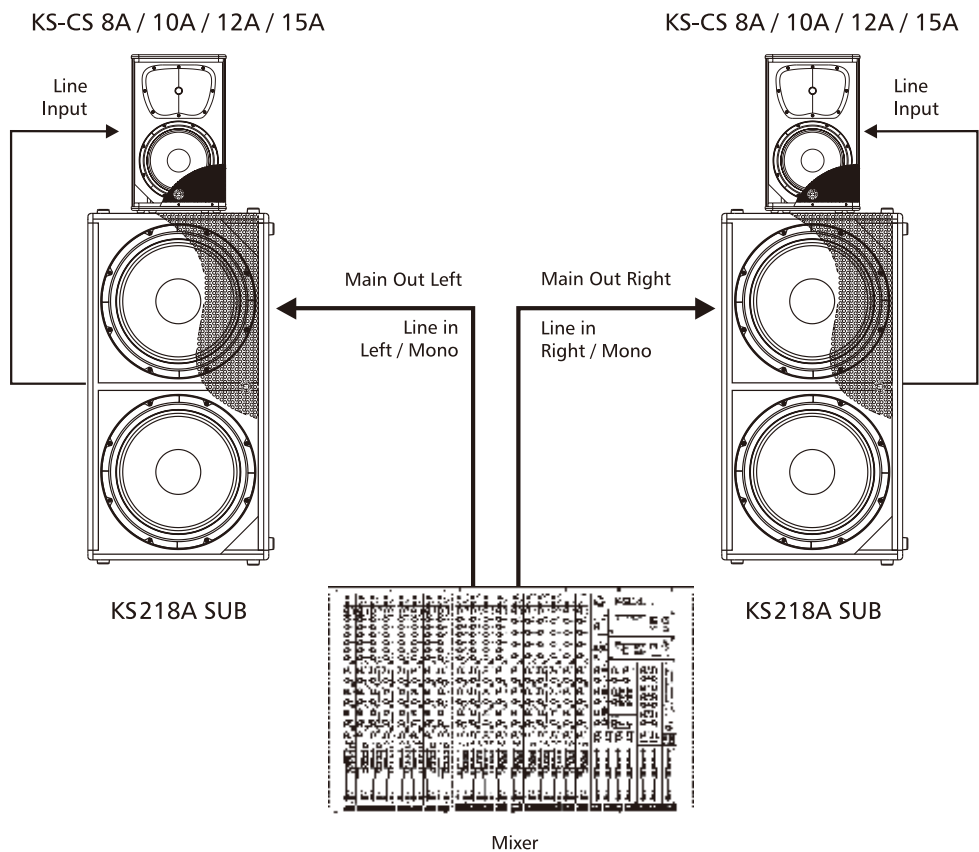
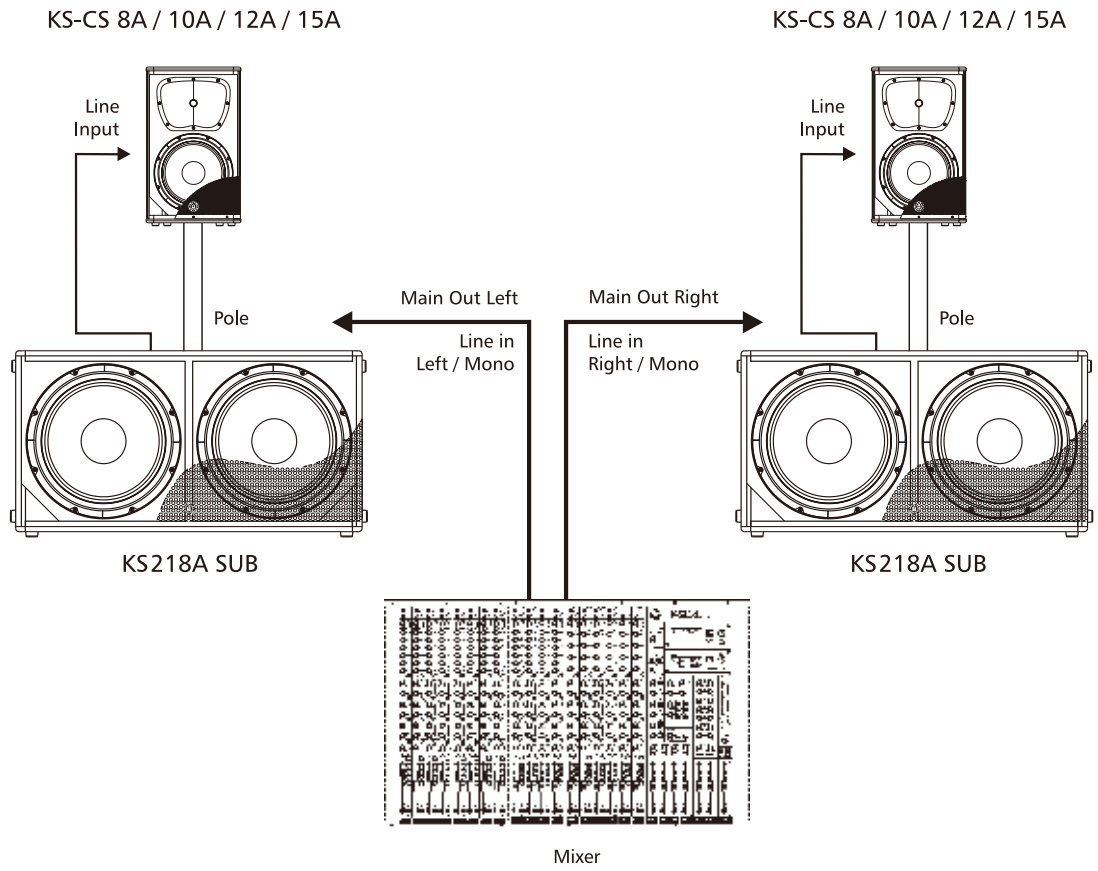

## Frequency Response Diagrams

6

KS-CS 8A

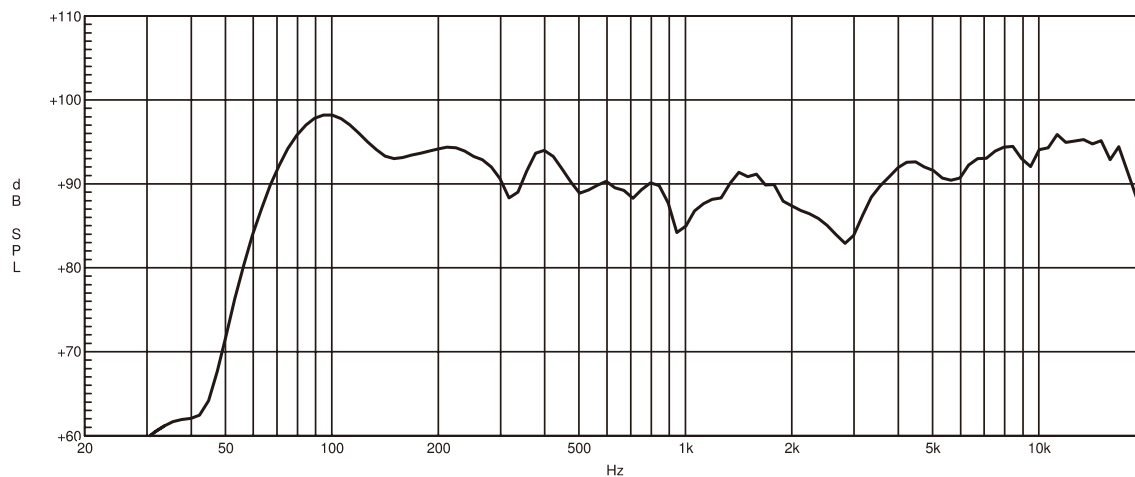

KS-CS 10A

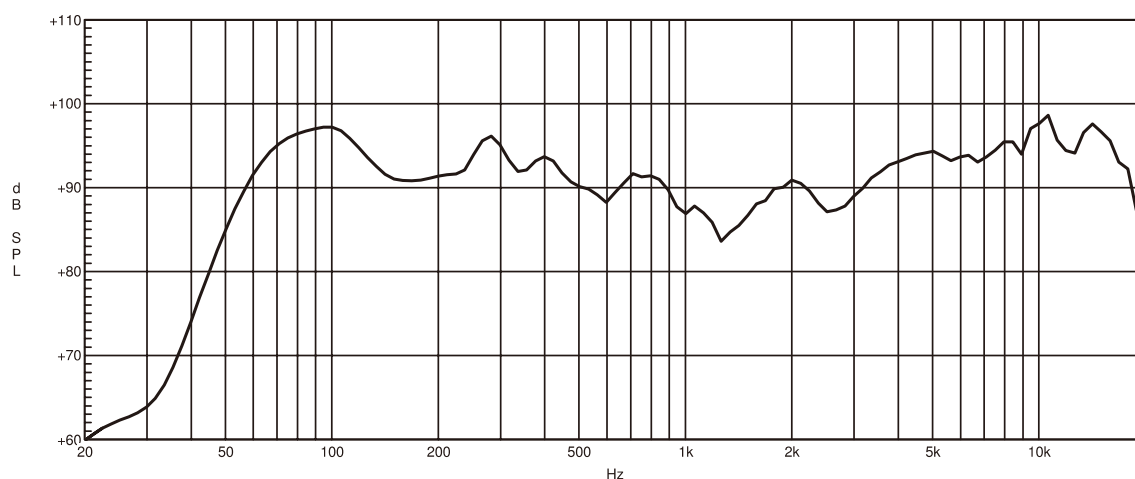

KS-CS 12A

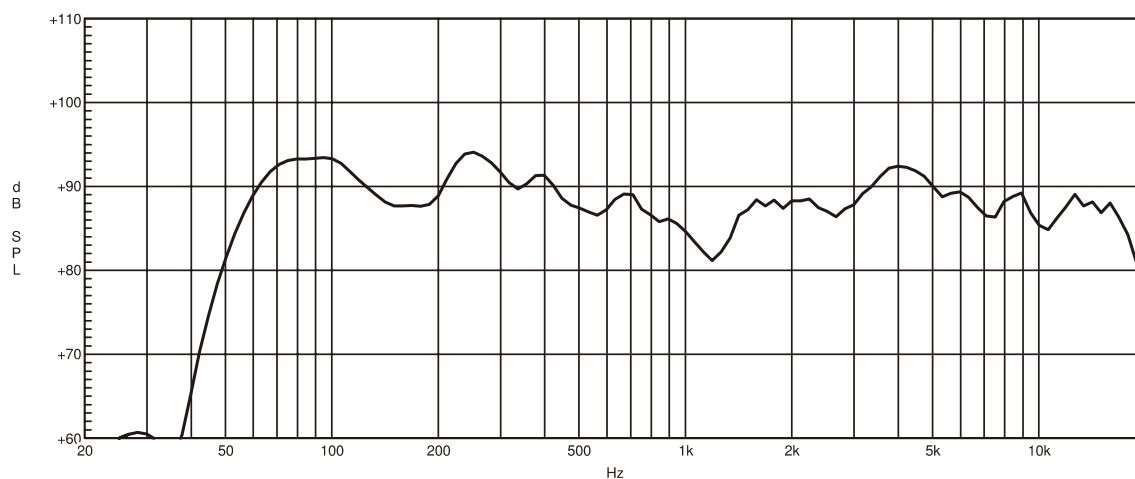

# 6

## Frequency Response Diagrams

KS-CS 15A

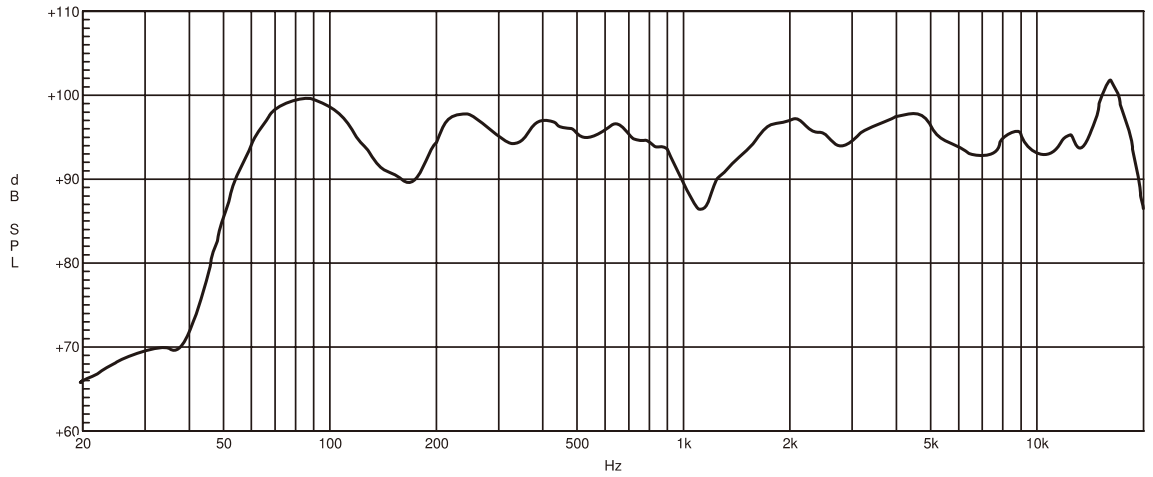

KS-CS 215A

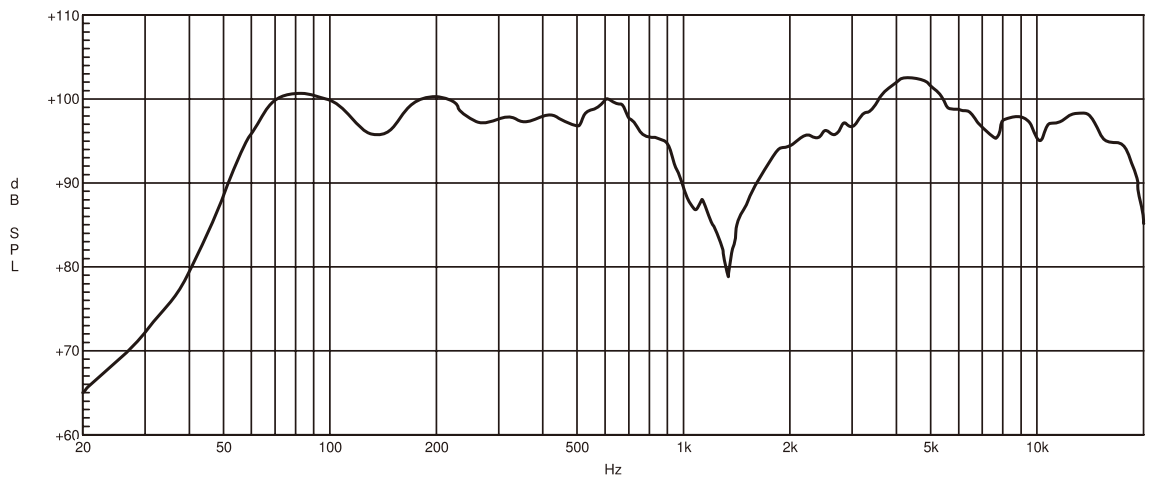

KS15A SUB

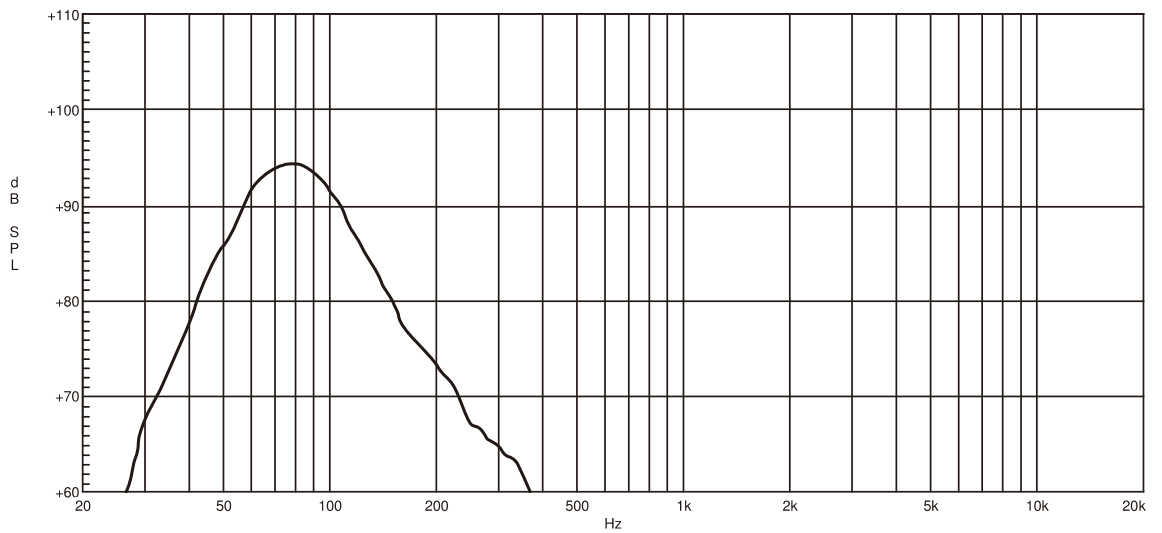

## Frequency Response Diagrams

6

KS18A SUB

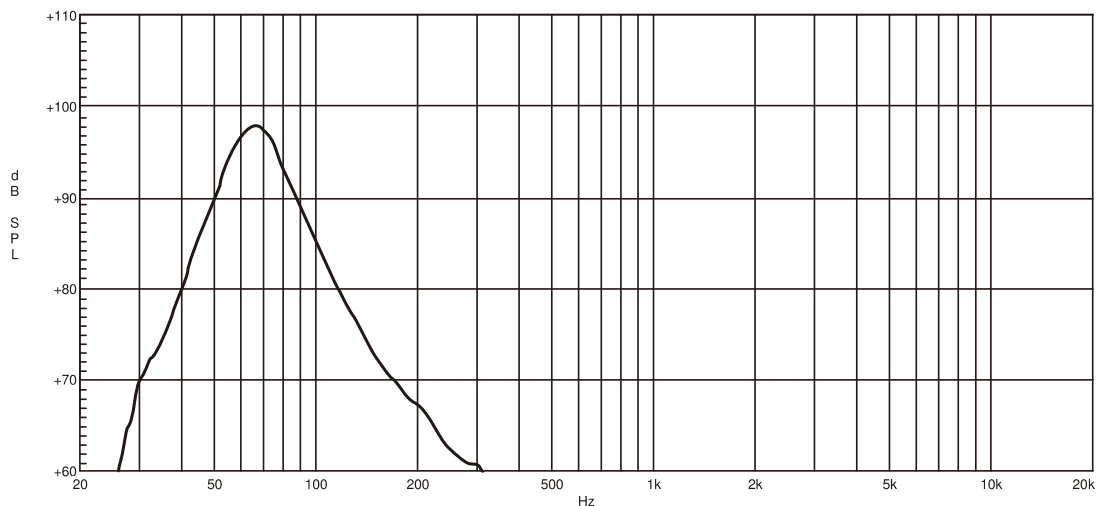

KS218A SUB

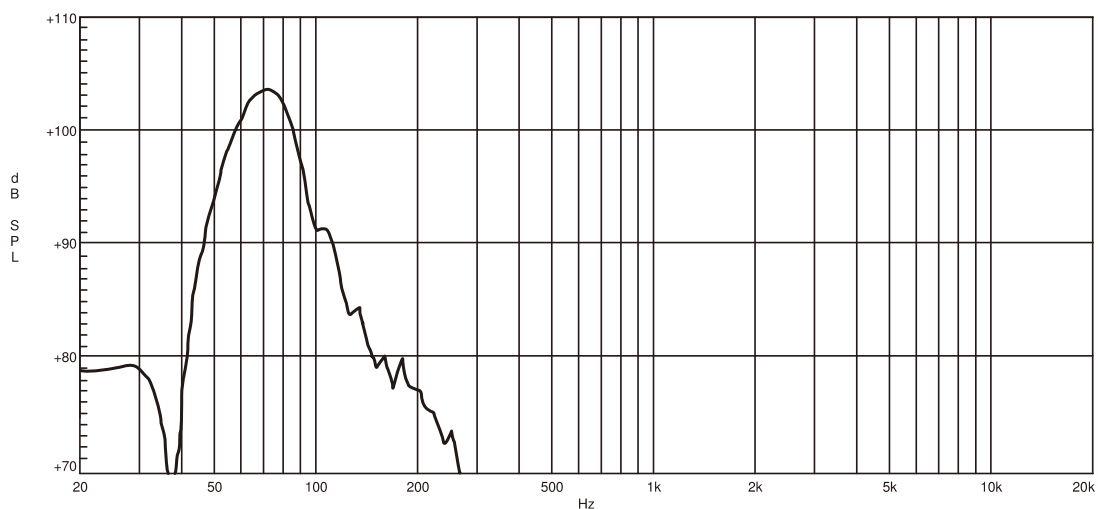

KS 21A SUB

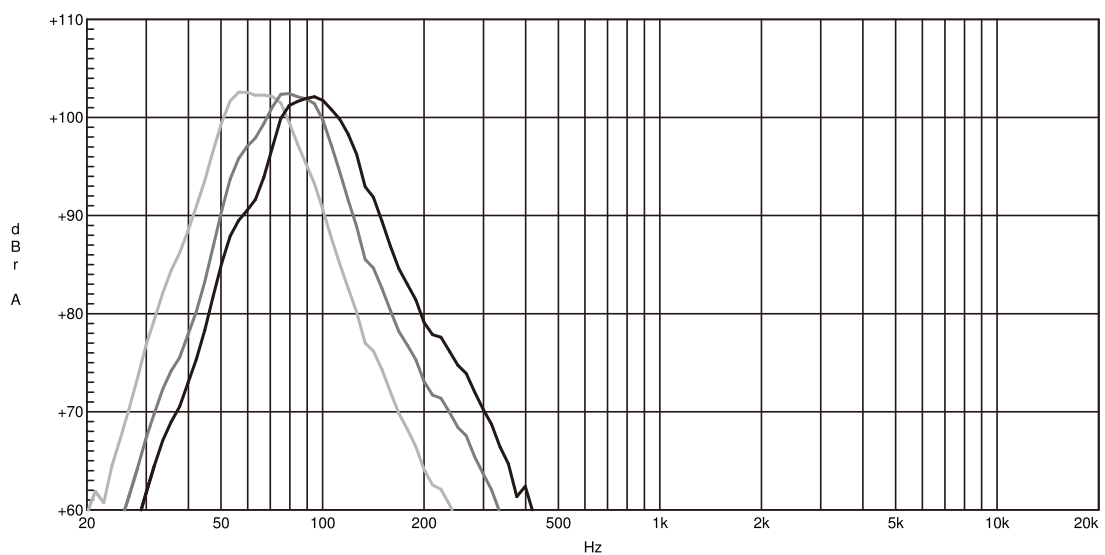

# 7

## Wire Connections

Either the 1/4" TRS phone jack or XLR connector can be wired in balanced and unbalanced modes, which will be determined by the actual application status, please wire your system as the following wiring examples:

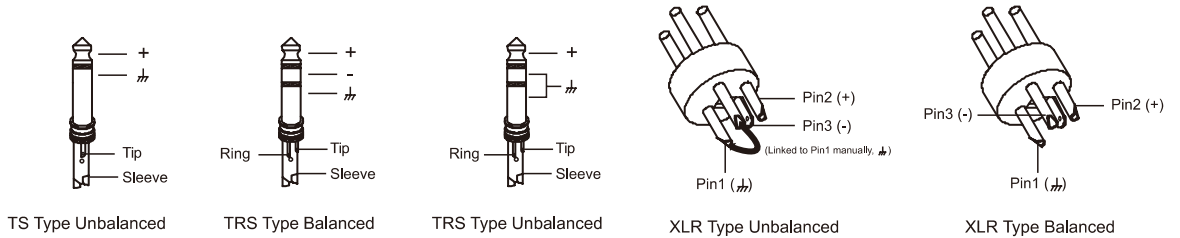

### In-line Connection

For these applications the unit provides 1/4" TRS and XLR connectors to easily interface with most professional audio devices. Follow the configuration examples below for your particular connection:

#### • Balanced

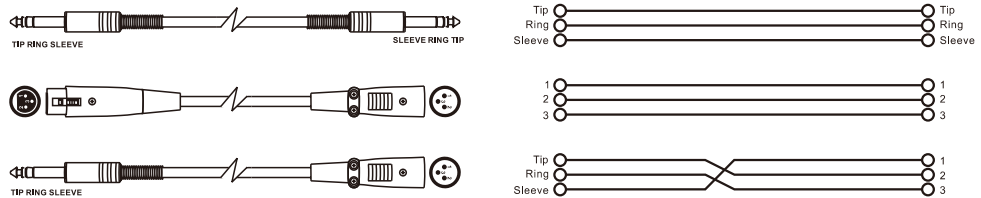

#### • Unbalanced

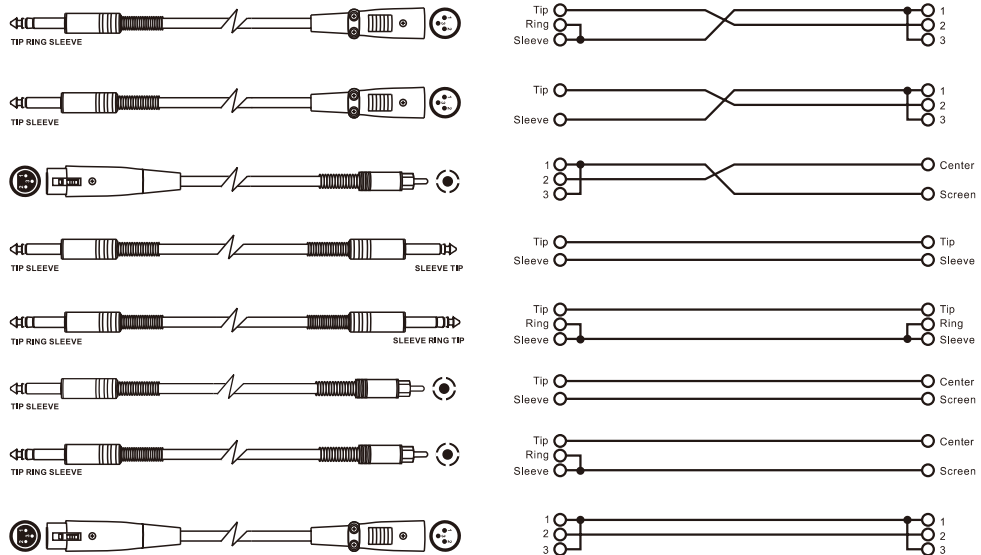

## Technical Specifications

8

Model Active	<b>KS-CS 8A</b>
System Type	2-Way Active Loudspeaker with DSP
Transducer Low	8" Woofer, 2" voice coil
Transducer Driver	1" Compression Driver, 1.75" Voice Coil
Frequency Response (-6dB)	60Hz-20KHz
Crossover Frequency	At 1.8K Hz with 24db filter slope, Linkwitz-Riley Type
Max. SPL	124dB Max.
Power Rating	800W Continuous, BI-AMP (Class D-650W LF, Class AB-150W HF), 1600W Peak
Input Connector	Line/Mic - Combo/Link - XLR
DSP Presets	Flat / Loudness / User (Custom Sound)
Line Input	Combo Connector -6dBu
External Controls	Volume Control / Power ON with Green LED / Clip Limiter with Red LED / Ground Lift / Switch for Input Sens. / Switch On for front Led / IP Control Module (Optional)
Electronic Protections	Thermal / Convection-Fan / Overload / Digital Lim. / Compressor
Power Supply	110-120V~50/60Hz or 220-240V~50/60Hz Switchable
Enclosure Construction	Plywood cabinet, resistant black paint, metal grille with black foam, rubber feet, plastic handle
Mounting	One metal standard pole-mount, 10xM10 Flying Points
Dimensions (HxWxD)	18.11" (460mm) x 11.28" (286.4mm) x 12.21" (310mm)
Net weight	15.93kg / 35.05lbs

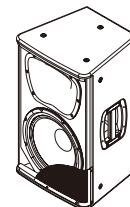

Model Active	<b>KS-CS 10A</b>
System Type	2-Way Active Loudspeaker with DSP
Transducer Low	10" Woofer, 2.5" voice coil
Transducer Driver	1" Compression Driver, 1.75" Voice Coil
Frequency Response (-6dB)	55Hz-20KHz
Crossover Frequency	At 1.8K Hz with 24db filter slope, Linkwitz-Riley Type
Max. SPL	126dB Max.
Power Rating	800W Continuous, BI-AMP (Class D-650W LF, Class AB-150W HF), 1600W Peak
Input Connector	Line/Mic - Combo/Link - XLR
DSP Presets	Flat / Loudness / User (Custom Sound)
Line Input	Combo Connector -6dBu
External Controls	Volume Control / Power ON with Green LED / Clip Limiter with Red LED / Ground Lift / Switch for Input Sens. / Switch On for front Led / IP Control Module (Optional)
Electronic Protections	Thermal / Convection-Fan / Overload / Digital Lim. / Compressor
Power Supply	110-120V~50/60Hz or 220-240V~50/60Hz Switchable
Enclosure Construction	Plywood cabinet, resistant black paint, metal grille with black foam, rubber feet, plastic handle
Mounting	One metal standard pole-mount, 12xM10 Flying Points
Dimensions (HxWxD)	22.95" (583mm) x 13.12" (333.2mm) x 12.8" (325mm)
Net weight	19.72kg / 43.49lbs

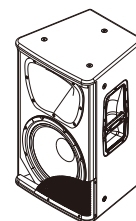

8

**Technical Specifications**

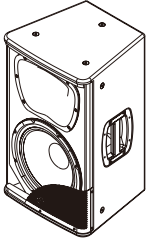

Model Active	<b>KS-CS 12A</b>
System Type	2-Way Active Loudspeaker with DSP
Transducer Low	12" Woofer, 3" voice coil
Transducer Driver	1" Compression Driver, 1.75" Voice Coil
Frequency Response (-6dB)	50Hz-20KHz
Crossover Frequency	At 1.6K Hz with 24db filter slope, Linkwitz-Riley Type
Max. SPL	128dB Max.
Power Rating	1000W Continuous Class D BI-AMP (500W LF, 500W HF), 2000W Peak
Input Connector	Line/Mic - Combo/Link - XLR
DSP Presets	Flat / Loudness / User (Custom Sound)
Line Input	Combo Connector -6dBu
External Controls	Volume Control / Power ON with Green LED / Clip Limiter with Red LED / Ground Lift / Switch for Input Sens. / Switch On for front Led / IP Control Module (Optional)
Electronic Protections	Thermal / Convection-Fan / Overload / Digital Lim. / Compressor
Power Supply	110-120V~50/60Hz or 220-240V~50/60Hz Switchable
Enclosure Construction	Plywood cabinet, resistant black paint, metal grille with black foam, rubber feet, plastic handle
Mounting	One metal standard pole-mount, 12xM10 Flying Points
Dimensions (HxWxD)	24.6" (625mm) x 15" (380mm) x 13.8" (350mm)
Net weight	23.18kg / 51.1lbs

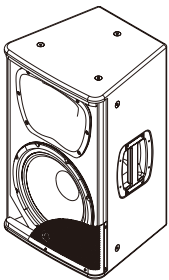

Model Active	<b>KS-CS 15A</b>
System Type	2-Way Active Loudspeaker with DSP
Transducer Low	15" Woofer, 3" voice coil
Transducer Driver	1" Compression Driver, 1.75" Voice Coil
Frequency Response (-6dB)	48Hz-20KHz
Crossover Frequency	At 1.5K Hz with 24db filter slope, Linkwitz-Riley Type
Max. SPL	130dB Max.
Power Rating	1000W Continuous Class D BI-AMP (500W LF, 500W HF), 2000W Peak
Input Connector	Line/Mic - Combo/Link - XLR
DSP Presets	Flat / Loudness / User (Custom Sound)
Line Input	Combo Connector -6dBu
External Controls	Volume Control / Power ON with Green LED / Clip Limiter with Red LED / Ground Lift / Switch for Input Sens. / Switch On for front Led / IP Control Module (Optional)
Electronic Protections	Thermal / Convection-Fan / Overload / Digital Lim. / Compressor
Power Supply	110-120V~50/60Hz or 220-240V~50/60Hz Switchable
Enclosure Construction	Plywood cabinet, resistant black paint, metal grille with black foam, rubber feet, plastic handle
Mounting	One metal standard pole-mount, 12xM10 Flying Points
Dimensions (HxWxD)	27.6" (700mm) x 16.9" (430mm) x 15.2" (386mm)
Net weight	26.16kg / 57.7lbs



## Technical Specifications

8

Model Active	<b>KS-CS 215A</b>
System Type	2-Way Active Loudspeaker with DSP
Transducer Low	2 x 15" Woofer, 3" voice coil
Transducer Driver	1" Compression Driver, 1.75" Voice Coil
Frequency Response (-6dB)	45Hz-20KHz
Crossover Frequency	At 1.5K Hz with 24db filter slope, Linkwitz-Riley Type
Max. SPL	133dB Max.
Power Rating	1000W Continuous Class D BI-AMP (500W LF, 500W HF), 2000W Peak
Input Connector	Line/Mic - Combo/Link - XLR
DSP Presets	Flat / Loudness / User (Custom Sound)
Line Input	Combo Connector -6dBu
External Controls	Volume Control / Power ON with Green LED / Clip Limiter with Red LED / Ground Lift / Switch for Input Sens. / Switch On for front Led / IP Control Module (Optional)
Electronic Protections	Thermal / Convection-Fan / Overload / Digital Lim. / Compressor
Power Supply	110-120V~50/60Hz or 220-240V~50/60Hz Switchable
Enclosure Construction	Plywood cabinet, resistant black paint, metal grille with black foam, rubber feet, plastic handle
Mounting	12xM10 Flying Points
Dimensions (HxWxD)	43.4" (1100mm) x 16.9" (430mm) x 15.2" (386mm)
Net weight	39.12g / 86..2lbs

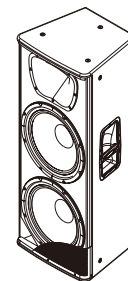

Model Active	<b>KS15A SUB</b>
System Type	Active Subwoofer
Power Rating	1000W Continuous Class D, Program 2000W, Peak 4000W
Woofer	15" Woofer, 3" Voice Coil
Max. SPL	128 dB
Frequency Response (-6dB)	45Hz to 120Hz
Crossover Frequency	Low pass band type 12dB/oct.
Connectors	Input: Left Mono (Combo) / Right (XLR-F) / Output: Left Mono / Right (XLR-M), Link-Left / Mono-Right (XLR-M)
External Controls	Volume Control / Phase Switch / HPF-100Hz for L-R Satellite or By Pass / Power ON with Green LED / Clip Limiter with Red LED / Ground Lift
Electronic Protections	Thermal / Convection-Fan / Overload / Lim./Compressor
Power Supply	Seleccionable 110-120V-50/60Hz / 220-240V-50/60Hz
Enclosure Construction	Plywood cabinet, resistant black paint, metal grille with black foam, rubber feet, double handle
Mounting	One metal standard pole-mount
Dimensions (HxWxD)	17.72 (450mm) x 22.84" (580mm) x 19.1" (485mm)
Net weight	24.95Kg / 55.03Lbs.

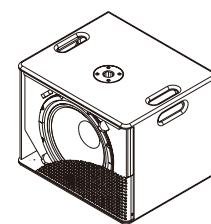

8

**Technical Specifications**

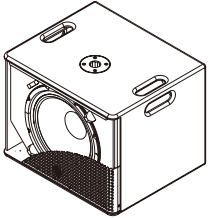

Model Active	<b>KS18A SUB</b>
System Type	Active Subwoofer
Power Rating	1000W Continuous Class D, Program 2000W, Peak 4000W
Woofer	18" Woofer, 3" Voice Coil
Max. SPL	129 dB
Frequency Response (-6dB)	40Hz to 120Hz
Crossover Frequency	Low pass band type 12dB/oct.
Connectors	Input: Left Mono (Combo) / Right (XLR-F) / Output: Left Mono / Right (XLR-M), Link-Left / Mono-Right (XLR-M)
External Controls	Volume Control / Phase Switch / HPF-100Hz for L-R Satellite or By Pass / Power ON with Green LED / Clip Limiter with Red LED / Ground Lift
Electronic Protections	Thermal / Convection-Fan / Overload / Lim./Compressor
Power Supply	Seleccionable 110-120V-50/60Hz / 220-240V-50/60Hz
Enclosure Construction	Plywood cabinet, resistant black paint, metal grille with black foam, rubber feet, double handle
Mounting	One metal standard pole-mount
Dimensions (HxWxD)	21.06" (535mm) x 26.02" (661mm) x 20.3" (515mm)
Net weight	31.84Kg / 70.02Lbs.

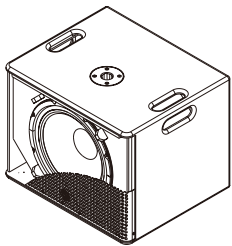

Model Active	<b>KS 21A SUB</b>
System Type	Active Subwoofer
Power Rating	1000W Continuous Class D, Program 2000W, Peak 4000W
Woofer	21" Woofer, 4" Voice Coil
Max. SPL	130 dB
Frequency Response (-6dB)	40Hz to 120Hz
Crossover Frequency	DSP Processing 60Hz / 80Hz / 100Hz
Connectors	Input: Left Mono (Combo) / Right (XLR-F) / Output: Left Mono / Right (XLR-M), Link-Left / Mono-Right (XLR-M)
External Controls	Volume Control / DSP Processing / Phase Switch / HPF-80Hz for L-R Satellite or By Pass / Power ON with Green LED / Clip Limiter with Red LED / Ground Lift
Electronic Protections	Thermal / Convection-Fan / Overload / Lim./Compressor
Power Supply	Neutrik POWER CON® connector, 110-120V / 220-240V-50/60Hz Switchable
Enclosure Construction	Plywood cabinet, resistant black paint, metal grille with black foam, rubber feet, double handle
Mounting	One metal standard pole-mount
Dimensions (HxWxD)	29.3"(745mm) x 24.6"(625mm) x 22.8"(578mm)
Net weight	48Kg / 105.8Lbs.

## Technical Specifications

8

Model Active	<b>KS218A SUB</b>
System Type	Active Subwoofer
Power Rating	2000W Continuous Class D, Program 4000W, Peak 8000W
Woofers	2 x 18" Woofer, 3" Voice Coil
Max. SPL	133 dB
Frequency Response (-6dB)	35Hz to 120Hz
Crossover Frequency	Low pass band type 12dB/oct , Analog processor.
Connectors	Input: Left Mono (Combo) / Right (XLR-F) / Output: Left Mono / Right (XLR-M), Link-Left / Mono-Right (XLR-M)
External Controls	Volume Control / Phase Switch / HPF-100Hz for L-R Satellite or By Pass / Power ON with Green LED / Clip Limiter with Red LED / Ground Lift
Electronic Protections	Thermal / Convection-Fan / Overload / Lim./Compressor
Power Supply	Neutrik POWER CON® connector, 110-120V / 220-240V-50/60Hz Switchable
Enclosure Construction	Plywood cabinet, resistant black paint, metal grille with black foam, rubber feet, double handle
Mounting	One metal standard pole-mount
Dimensions (HxWxD)	21.06" (535mm) x 20.41" (518mm) x 52.36" (1000mm)
Net weight	46.64Kg / 102.82Lbs.

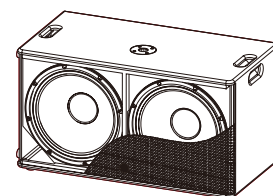

# 9

## Guarantee

---

**Topp Pro** guarantees the normal operation of the product against any defect of manufacture and/or vice of material, by the term of (12) months, counted as of the date of purchase on the part of the user, committing itself to repair or to change, to its election, without position some, any piece or component that will fail in normal conditions of use within the mentioned period.

This guarantee is valid if the original buyer will have to present/display this certificate properly sealed and signed by the selling house, accompanied by the corresponding invoice of purchase where it consisted the model and serial number of the acquired equipment.

The guarantee does not cover:

- Damages caused by the illegal use of the product, repair and/or nonauthorized modification conducted by people by **Topp Pro**.
- Damages caused by the connection of the equipment to other equipment different from the specified ones in the manual of use, or by bad connection to these last ones.
- Damages caused by electrical storms, blows and/or incorrect transport.
- Damages caused by excesses or falls of tension in the network or by connection to networks with a tension different from the required one by the unit.
- Damages caused by the presence of sand, acid of batteries, water, or any strange element inside the equipment.
- Deteriorations produced by the course of the time, use and/or normal wear of the unit.
- Alteration or absence of the serial number of factory of the equipment.

The repairs could only be carried out the authorized technical service by **Topp Pro**, that will inform about the term and other details into the repairs to take place according to this guarantee.

**Topp Pro**, will repair this unit in counted a term nongreater to 30 days as of the date of entrance of the unit to the Technical Service. In those cases in that due to the particularity of the spare part, outside necessary their import, the repair time and the viability of the same one will be subject to the effective norms for the import of parts, in which case one will inquire to the user about the term and possibility into repair.

With the object of its correct operation, and of the validity of this one guarantee, this product will have to be installed and to be used according to the instructions that are detailed in the manual associate or the package of the product.

This unit will be able to appear for its repair, next to the invoice of purchase (or any other proof where the date of purchase consists), to its authorized distributor **Topp Pro** or an authorized technical center on watch by **Topp Pro**.

**Exclusion of damages:**

**THE RESPONSABILITY OF TOPP PRO BY ANY DEFECTIVE PRODUCT IS LIMITED THE REPAIR OR THE REPLACEMENT OF HE HIMSELF, TO TOPP OPTION PRO. IF WE CHOSE TO REPLACE THE PRODUCT, THE REPLACEMENT CAN BE A RECONDITIONATED UNIT. TOPP PRO WILL NOT BE RESPONSIBLE BY THE DAMAGES BASED ON THE LOST, INCONVENIENCE, LOSS OF USE, BENEFITS, LOST SAVINGS, BY THE DAMAGE TO OTHER EQUIPMENT OR OTHER ARTICLES IN THE USE SITE, OR BY ANY OTHER DAMAGE IF HE IS FORTUITOUS, CONSEQUENT OR OF ANOTHER TYPE, ALTHOUGH TOPP PRO HAS BEEN NOTICED OF THE POSSIBILITY OF SUCH DAMAGES.**

Some states do not allow to the exclusion or the limitation to the fortuitous or consequent damages, so the aforesaid limitation can not be applied to you.

This guarantee gives specific legal rights him, you you can also have other right that varies of state to state.





***TOPP PRO MUSIC GEAR***

*[www.topppro.com](http://www.topppro.com)*

***KS-CS***  
***S E R I E S***